

EIGENSCHAFTEN

- Funktion durch mechanische Überlagerung zwischen Gewinde und Beton.
- Für schwere Lasten.
- Zugelassen für 2 Einbautiefen bzw. bis zu 3 für $\varnothing 10$.
- Geeignet für ungerissenen und gerissenen Beton.
- Erfüllt die Richtlinie VdS CEA 4001:2021-01(07) „Richtlinien für Sprinkleranlagen. Planung und Einbau“
- Besonders geeignet bei geringen Abständen zwischen Ankeren bzw. Rändern.
- Einsatz für statische oder quasistatische Lasten.
- Einfache Montage.
- Installation mit der Bohrung des Anbauteils.
- Vorbohren erforderlich; das Gewinde wird beim Einbau des Ankers im Baustoff erstellt.
- Wiederverwendbar
- Ausbau möglich, ohne auf dem Untergrund des Grundmaterials Spuren zu hinterlassen.
- Verschiedene Längen und Größen, flexibler Einbau.
- VdS verfügbar von $\varnothing 6$ bis $\varnothing 18$
- Verfügbar in INDEXcal

ANWENDUNGEN

- Konstruktive Befestigungen in gerissenem und ungerissenem Beton in Innenräumen
- Verglasungen, Fenster und Schaufenster
- Regale und Rohrgestelle
- Montage von Geländern und Handläufen in Innenbereichen
- Befestigungen von Holzbauten an Beton.

ZULASSUNGEN



BAUSTOFFE



VERFÜGBARE GRÖßEN

$\varnothing 5 - \varnothing 18$

BOHRLOCHBEDINGUNGEN



TROCKEN

NASS





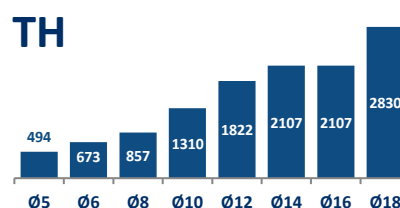



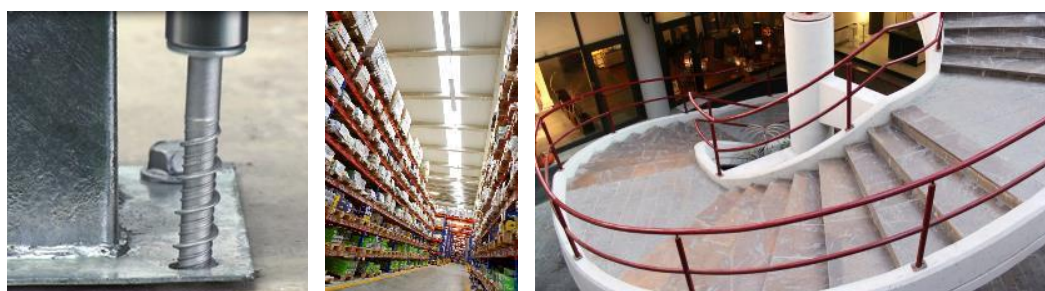









MIT
WASSER
GEFÜLLT

MAX. EMPFOHLENE ZUGTRAGFÄHIGKEIT
IN GERISSENEM UND UNGERISSENEM
BETON [kg]



ANWENDUNGSBEISPIEL

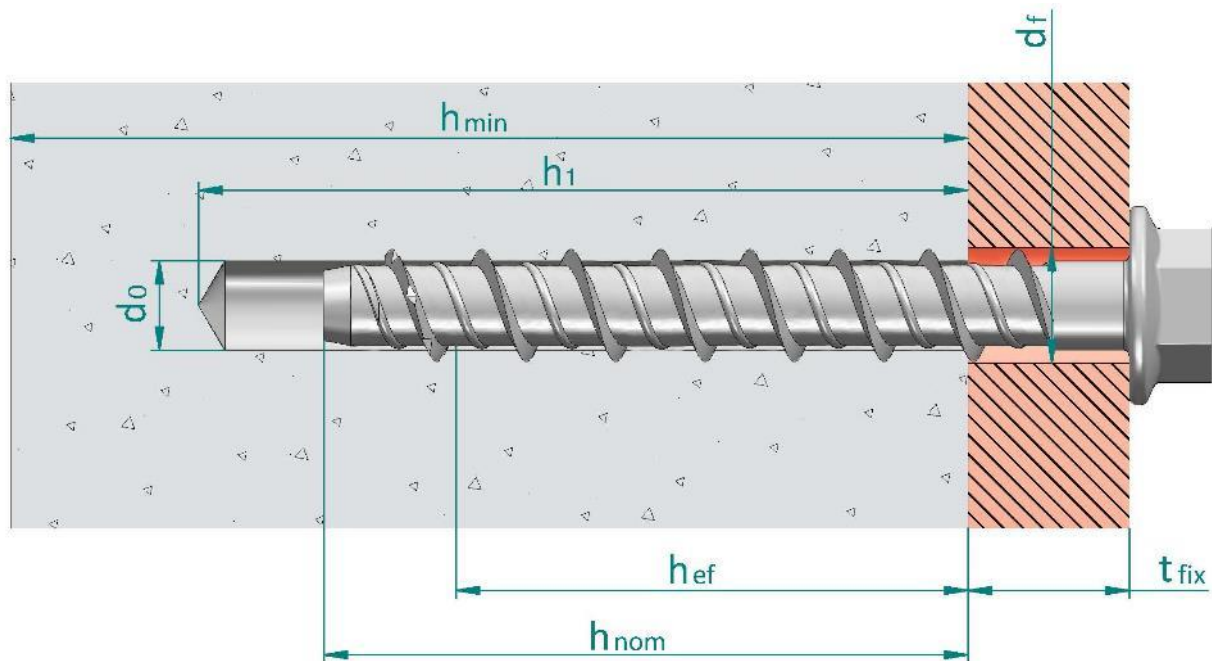

1. SORTIMENT						
POS.	ARTIKELN	GRÖÖE	FOTO	BESCHREIBUNG	MATERIAL	BESCHICHTUNG
1	THE	Ø5 - Ø18		Sechskant-Flanschkopf mit Bund	Gestanzter Kohlenstoffstahl, ATLANTIS-Beschichtung	
2	TFE	Ø5 - Ø18		Sechskant-Flanschkopf mit Bund	Gestanzter Kohlenstoffstahl, verzinkt ≥ 5 µm	
3	TFN	Ø14		Sechskantkopf	Gestanzter Kohlenstoffstahl, verzinkt ≥ 5 µm	
4	THA	Ø5 - Ø10		Senkkopf	Gestanzter Kohlenstoffstahl, ATLANTIS-Beschichtung	
5	THT	Ø6		Flachrundkopf	Gestanzter Kohlenstoffstahl, ATLANTIS-Beschichtung	
6	THP	Ø5 - Ø8		Linsenkopf	Gestanzter Kohlenstoffstahl, ATLANTIS-Beschichtung	
7	TFF	Ø6		Kopf mit Hülse	Gestanzter Kohlenstoffstahl, verzinkt ≥ 5 µm	
8	TFM	Ø6		Sechskant-Flanschkopf mit überstehender Achse	Gestanzter Kohlenstoffstahl, verzinkt ≥ 5 µm	
9	TFS	Ø6 - Ø10		Kopf mit überstehender Achse, Unterlegscheibe und Mutter	Gestanzter Kohlenstoffstahl, verzinkt ≥ 5 µm	

2. EINBAUHINWEISE**2.1. EINBAUPLAN**

- d_0 : Nenn-Bohrungsdurchmesser
- d_f : Durchmesser des Durchgangslochs im Anbauteil
- h_{ef} : Effektive Verankerungstiefe
- h_1 : Bohrlochtiefe
- h_{nom} : Verankerungstiefe im Beton
- h_{min} : Minimale Betondicke
- t_{fix} : Dicke des Anbauteils

2.2. ERDBEBENZULASSUNG

Familie	Artikelnr.	Größe (Buchstabe)	Zulassung	C1	C2	Familie	Artikelnr.	Größe	Zulassung	C1	C2	
[--]	[--]	[--]	ETA	[--]	[--]	[--]	[--]	[--]	ETA	[--]	[--]	
THE	THE05040	Ø5 x 40 (A)	✓*	--	--	TFE	TFE05040	Ø5 x 40 (A)	✓*	--	--	
	THE05050	Ø5 x 50 (A)	✓*	--	--		TFE05050	Ø5 x 50 (A)	✓*	--	--	
	THE05060	Ø5 x 60 (B)	✓*	--	--		TFE05060	Ø5 x 60 (B)	✓*	--	--	
	THE05080	Ø5 x 80 (D)	✓*	--	--		TFE05080	Ø5 x 80 (D)	✓*	--	--	
	THE05100	Ø5 x 100 (E)	✓*	--	--		TFE05100	Ø5 x 100 (E)	✓*	--	--	
	THE06040	Ø6 x 40	✓	--	--		TFE06040	Ø6 x 40	✓	--	--	
	THE06050	Ø6 x 50	✓	✓	--		TFE06050	Ø6 x 50	✓	✓	--	
	THE06060	Ø6 x 60	✓	✓	--		TFE06060	Ø6 x 60	✓	✓	--	
	THE06070	Ø6 x 70	✓	✓	--		TFE06070	Ø6 x 70	✓	✓	--	
	THE06080	Ø6 x 80	✓	✓	--		TFE06080	Ø6 x 80	✓	✓	--	
	THE06100	Ø6 x 100	✓	✓	--		TFE06100	Ø6 x 100	✓	✓	--	
	THE06120	Ø6 x 120	✓	✓	--		TFE06120	Ø6 x 120	✓	✓	--	
	THE08055	Ø8 x 55	✓	✓	✓		TFE08055	Ø8 x 55	✓	✓	✓	✓
	THE08060	Ø8 x 60	✓	✓	✓		TFE08060	Ø8 x 60	✓	✓	✓	✓
	THE08070	Ø8 x 70	✓	✓	✓		TFE08070	Ø8 x 70	✓	✓	✓	✓
	THE08080	Ø8 x 80	✓	✓	✓		TFE08080	Ø8 x 80	✓	✓	✓	✓
	THE08090	Ø8 x 90	✓	✓	✓		TFE08090	Ø8 x 90	✓	✓	✓	✓
	THE08100	Ø8 x 100	✓	✓	✓		TFE08100	Ø8 x 100	✓	✓	✓	✓
	THE08110	Ø8 x 110	✓	✓	✓		TFE08110	Ø8 x 110	✓	✓	✓	✓
	THE08120	Ø8 x 120	✓	✓	✓		TFE08120	Ø8 x 120	✓	✓	✓	✓
	THE08140	Ø8 x 140	✓	✓	✓		TFE08140	Ø8 x 140	✓	✓	✓	✓
	THE10060	Ø10 x 60	✓	--	--		TFE10060	Ø10 x 60	✓	--	--	--
	THE10070	Ø10 x 70	✓	--	--		TFE10070	Ø10 x 70	✓	--	--	--
	THE10080	Ø10 x 80	✓	--	--		TFE10080	Ø10 x 80	✓	--	--	--
	THE10090	Ø10 x 90	✓	✓	✓		TFE10090	Ø10 x 90	✓	✓	✓	✓
	THE10100	Ø10 x 100	✓	✓	✓		TFE10100	Ø10 x 100	✓	✓	✓	✓
	THE10120	Ø10 x 120	✓	✓	✓		TFE10120	Ø10 x 120	✓	✓	✓	✓
	THE10140	Ø10 x 140	✓	✓	✓		TFE10140	Ø10 x 140	✓	✓	✓	✓
	THE12080	Ø12 x 80	✓	--	--		TFE12080	Ø12 x 80	✓	--	--	--
	THE12090	Ø12 x 90	✓	--	--		TFE12090	Ø12 x 90	✓	--	--	--
	THE12110	Ø12 x 110	✓	✓	✓		TFE12110	Ø12 x 110	✓	✓	✓	✓
	THE12130	Ø12 x 130	✓	✓	✓		TFE12130	Ø12 x 130	✓	✓	✓	✓
	THE12150	Ø12 x 150	✓	✓	✓		TFE12150	Ø12 x 150	✓	✓	✓	✓
	THE14080	Ø14 x 80	✓	--	--		TFE14080	Ø14 x 80	✓	--	--	--
	THE14100	Ø14 x 100	✓	--	--		TFE14100	Ø14 x 100	✓	--	--	--
	THE14120	Ø14 x 120	✓	✓	✓		TFE14120	Ø14 x 120	✓	✓	✓	✓
	THE14130	Ø14 x 130	✓	✓	✓		TFE14130	Ø14 x 130	✓	✓	✓	✓
	THE14140	Ø14 x 140	✓	✓	✓		TFE14140	Ø14 x 140	✓	✓	✓	✓
	THE14160	Ø14 x 160	✓	✓	✓		TFE14160	Ø14 x 160	✓	✓	✓	✓
	THE16100	Ø16 x 100	✓	--	--		TFE16100	Ø16 x 100	✓	--	--	--
	THE16150	Ø16 x 100	✓	--	--		TFE16150	Ø16 x 100	✓	--	--	--
	THE18100	Ø18 x 100	✓	--	--		TFE18100	Ø18 x 100	✓	--	--	--
THE18130	Ø18 x 130	✓	--	--	TFE18130	Ø18 x 130	✓	--	--	--		
THE18160	Ø18 x 160	✓	✓	✓	TFE18160	Ø18 x 160	✓	✓	✓	✓		
THE18180	Ø18 x 180	✓	✓	✓	TFE18180	Ø18 x 180	✓	✓	✓	✓		
THE18200	Ø18 x 200	✓	✓	✓	TFE18200	Ø18 x 200	✓	✓	✓	✓		
TFF	TFF06035	Ø6 x 35 (M8-M10)	✓	--	--	THT	THT06040	Ø6 x 40	✓	--	--	
	TFF06055	Ø6 x 55 (M8-M10)	✓	✓	--		THT06050	Ø6 x 50	✓	✓	--	
TFM	TFM06035	Ø6 x 35 (M8)	✓	--	--		THT06060	Ø6 x 60	✓	✓	--	
	TFM06055	Ø6 x 55 (M10)	✓	✓	--							

Familie	Artikelnr.	Größe (Buchstabe)	Zulassung	C1	C2	Familie	Artikelnr.	Größe	Zulassung	C1	C2	
[--]	[--]	[--]	ETA	[--]	[--]	[--]	[--]	[--]	ETA	[--]	[--]	
THA	THA05040	Ø5 x 40 (A)	✓*	--	--	TFS	TFS06100	Ø6 x 100 (M8)	✓	✓	--	
	THA05060	Ø5 x 60 (B)	✓*	--	--		TFS06120	Ø6 x 120 (M8)	✓	✓	--	
	THA05080	Ø5 x 80 (D)	✓*	--	--		TFS08110	Ø8 x 110 (M10)	✓	✓	✓	
	THA05100	Ø5 x 100 (E)	✓*	--	--		TFS08130	Ø8 x 130 (M10)	✓	✓	✓	
	THA06045	Ø6 x 45	✓	--	--		TFS10120	Ø10 x 120 (M12)	✓	--	--	
	THA06050	Ø6 x 50	✓	✓	--		TFS10140	Ø10 x 140 (M12)	✓	--	--	
	THA06060	Ø6 x 60	✓	✓	--	TFN	TFN14080	Ø14 x 80	--	--	--	
	THA06080	Ø6 x 80	✓	✓	--	THP	THP05040	Ø5 x 40	✓*	--	--	
	THA06100	Ø6 x 120	✓	✓	--		THP05060	Ø5 x 60	✓*	--	--	
	THA06120	Ø6 x 120	✓	✓	--		THP06040	Ø6 x 40	✓	--	--	
	THA06140	Ø6 x 140	✓	✓	--		THP06050	Ø6 x 50	✓	✓	--	
	THA08060	Ø8 x 60	✓	✓	✓		THP06060	Ø6 x 60	✓	✓	--	
	THA08080	Ø8 x 80	✓	✓	✓		THP06080	Ø6 x 80	✓	✓	--	
	THA08100	Ø8 x 100	✓	✓	✓		THP06100	Ø6 x 100	✓	✓	--	
	THA08120	Ø8 x 120	✓	✓	✓		THP08060	Ø8 x 60	✓	✓	✓	
	THA10100	Ø10 x 100	✓	✓	✓		THP08080	Ø8 x 80	✓	✓	✓	
	THA10120	Ø10 x 120	✓	✓	✓							

3. EINBAUPARAMETER

Allgemeine Einbaukennwerte										Standard-Einbautiefe ($h_{ef, std}$)								Reduzierte Einbautiefe ($h_{ef, red}$)									
Familie	Artikelnr.	Größe (Buchstabe)	Zulassung	Bohrungsdurchmesser	Bohrlochdurchmesser der zu befestigenden	Einbauschlüssel	Max. Einbaudrehrmoment	Minimaler Achsabstand	Minimaler Abstand zum Rand	Minimale Betondicke	Bohrlochtiefe	Einbautiefe	Effektive Tiefe	Zu befestigende Dicke	Kritischer Achsabstand	Kritischer Abstand zum Rand (Ausbruch)	Kritischer Achsabstand (Spalten)	Kritischer Abstand zum Rand (Spalten)	Minimale Betondicke	Bohrlochtiefe	Einbautiefe	Effektive Tiefe	Zu befestigende Dicke	Kritischer Achsabstand	Kritischer Abstand zum Rand (Ausbruch)	Kritischer Achsabstand (Spalten)	Kritischer Abstand zum Rand (Spalten)
[--]	[--]	[--]	ETA	d_0 [mm]	d_f [mm]	SW/Tx [--]	T_{inst} [Nm]	S_{min} [mm]	C_{min} [mm]	h_{min} [mm]	h_1 [mm]	h_{nom} [mm]	h_{ef} [mm]	t_{fix} [mm]	$S_{cr,N}$ [mm]	$C_{cr,N}$ [mm]	$S_{cr,sp}$ [mm]	$C_{cr,sp}$ [mm]	h_{min} [mm]	h_1 [mm]	h_{nom} [mm]	h_{ef} [mm]	t_{fix} [mm]	$S_{cr,N}$ [mm]	$C_{cr,N}$ [mm]	$S_{cr,sp}$ [mm]	$C_{cr,sp}$ [mm]
THE	THE05040	Ø5 x 40(A)	✓*	5	8	SW 8	5	35	35	--	--	--	--	--	--	--	--	--	80	45	35	26,5	5	80	40	80	40
	THE05050	Ø5 x 50(A)	✓*			SW 8				5																	
	THE05060	Ø5 x 60(B)	✓*			SW 8				15																	
	THE05080	Ø5 x 80(D)	✓*			SW 8				35																	
	THE05100	Ø5 x 100(E)	✓*			SW 8				55																	
	THE06040	Ø6 x 40	✓	6	9	SW 10	10	35	35	--	--	--	--	--	--	--	--	--	100	45	35	26,0	5	100	39	90	45
	THE06050	Ø6 x 50	✓			SW 10				15																	
	THE06060	Ø6 x 60	✓			SW 10				25																	
	THE06070	Ø6 x 70	✓			SW 10				45																	
	THE06080	Ø6 x 80	✓			SW 10				65																	
	THE06100	Ø6 x 100	✓	SW 10	85																						
	THE06120	Ø6 x 120	✓	SW 10	100																						
	THE08055	Ø8 x 55	✓	8	12	SW 13	20	35	35	--	--	--	--	--	--	--	--	--	100	60	50	37,5	5	100	57	130	65
	THE08060	Ø8 x 60	✓			SW 13				10																	
	THE08070	Ø8 x 70	✓			SW 13				20																	
	THE08080	Ø8 x 80	✓			SW 13				30																	
	THE08090	Ø8 x 90	✓			SW 13				40																	
	THE08100	Ø8 x 100	✓			SW 13				50																	
	THE08110	Ø8 x 110	✓			SW 13				60																	
	THE08120	Ø8 x 120	✓			SW 13				70																	
	THE08140	Ø8 x 140	✓			SW 13				90																	
	THE10060	Ø10 x 60	✓			10				14	SW 15	30	50	40	--	--	--	--									
	THE10070	Ø10 x 70	✓	SW 15	15																						
	THE10080	Ø10 x 80	✓	SW 15	25																						
THE10090	Ø10 x 90	✓	SW 15	35																							
THE10100	Ø10 x 100	✓	SW 15	45																							
THE10120	Ø10 x 120	✓	SW 15	65																							
THE10140	Ø10 x 140	✓	SW 15	85																							

*Ø5 Zulassung nur für Verankerungen in Beton und vorgefertigten Spannbeton-Hohldecken für redundante nichttragende Systeme

Allgemeine Einbaukennwerte										Standard-Einbautiefe ($h_{ef, std}$)								Reduzierte Einbautiefe ($h_{ef, red}$)										
Familie	Artikelnr.	Größe (Buchstabe)	Zulassung	Bohrungsdurchmesser	Bohrlochdurchmesser der zu befestigenden	Einbauschlüssel	Max. Einbaudrehmoment	Minimaler Achsabstand	Minimaler Abstand zum Rand	Minimale Betondeicke	Bohrlochtiefe	Einbautiefe	Effektive Tiefe	Zu befestigende Dicke	Kritischer Achsabstand	Kritischer Abstand zum Rand (Ausbruch)	Kritischer Achsabstand (Spalten)	Kritischer Abstand zum Rand (Spalten)	Minimale Betondeicke	Bohrlochtiefe	Einbautiefe	Effektive Tiefe	Zu befestigende Dicke	Kritischer Achsabstand	Kritischer Abstand zum Rand (Ausbruch)	Kritischer Achsabstand (Spalten)	Kritischer Abstand zum Rand (Spalten)	
[--]	[--]	[--]	ETA	d_0	d_f	SW/Tx	T_{inst}	S_{min}	C_{min}	h_{min}	h_1	h_{nom}	h_{ef}	t_{fix}	$S_{cr,N}$	$C_{cr,N}$	$S_{cr,sp}$	$C_{cr,sp}$	h_{min}	h_1	h_{nom}	h_{ef}	t_{fix}	$S_{cr,N}$	$C_{cr,N}$	$S_{cr,sp}$	$C_{cr,sp}$	
				[mm]	[mm]	[--]	[Nm]	[mm]	[mm]	[mm]	[mm]	[mm]	[mm]	[mm]	[mm]	[mm]	[mm]	[mm]	[mm]	[mm]	[mm]	[mm]	[mm]	[mm]	[mm]	[mm]	[mm]	[mm]
THE	THE12080	Ø12 x 80	✓	12	16	SW 18	50	75	45	--	--	--	--	--	--	--	--	--	120	90	75	58,0	5	174	87	190	95	
	THE12090	Ø12 x 90	✓			SW 18				15																		
	THE12110	Ø12 x 110	✓			SW 18				5	251	126	220	110	35													
	THE12130	Ø12 x 130	✓			SW 18				25	251	126	220	110	55													
	THE12150	Ø12 x 150	✓	SW 18	45	251	126	220	110	75																		
	THE14080	Ø14 x 80	✓	14	18	SW 21	70	80	50	--	--	--	--	--	--	--	--	--	--	120	90	75	58,0	5	174	87	190	95
	THE14100	Ø14 x 100	✓			SW 21				25																		
	THE14120	Ø14 x 120	✓			SW 21				5	276	138	230	115	45													
	THE14130	Ø14 x 130	✓			SW 21				15	276	138	230	115	55													
	THE14140	Ø14 x 140	✓			SW 21				25	276	138	230	115	65													
	THE14160	Ø14 x 160	✓			SW 21				45	276	138	230	115	85													
	THE16100	Ø16 x 100	✓	16	20	SW24	80	80	50	--	--	--	--	--	--	--	--	--	115	100	80	58	20	174	87	180	90	
	THE16150	Ø16 x 150	✓			SW24				70																		
	THE18100	Ø18 x 100	✓	18	22	SW 24	90	90	55	--	--	--	--	--	--	--	--	--	--	140	110	90	69,5	10	209	105	230	115
	THE18130	Ø18 x 130	✓			SW 24				40																		
	THE18160	Ø18 x 160	✓			SW 24				20	336	168	350	175	70													
THE18180	Ø18 x 180	✓	SW 24			40				336	168	350	175	90														
THE18200	Ø18 x 200	✓	SW 24			60				336	168	350	175	110														

Allgemeine Einbaukennwerte										Standard-Einbautiefe ($h_{ef, std}$)								Reduzierte Einbautiefe ($h_{ef, red}$)									
Familie	Artikelnr.	Größe (Buchstabe)	Zulassung	Bohrungsdurchmesser	Bohrlochdurchmesser der zu befestigenden	Einbauschlüssel	Max. Einbaudrehmoment	Minimaler Achsabstand	Minimaler Abstand zum Rand	Minimale Betondecke	Bohrlochtiefe	Einbautiefe	Effektive Tiefe	Zu befestigende Dicke	Kritischer Achsabstand	Kritischer Abstand zum Rand (Ausbruch)	Kritischer Achsabstand (Spalten)	Kritischer Abstand zum Rand (Spalten)	Minimale Betondecke	Bohrlochtiefe	Einbautiefe	Effektive Tiefe	Zu befestigende Dicke	Kritischer Achsabstand	Kritischer Abstand zum Rand (Ausbruch)	Kritischer Achsabstand (Spalten)	Kritischer Abstand zum Rand (Spalten)
[--]	[--]	[--]	ETA	d_0 [mm]	d_f [mm]	SW/Tx [--]	T_{inst} [Nm]	S_{min} [mm]	C_{min} [mm]	h_{min} [mm]	h_1 [mm]	h_{nom} [mm]	h_{ef} [mm]	t_{fix} [mm]	$S_{cr,N}$ [mm]	$C_{cr,N}$ [mm]	$S_{cr,sp}$ [mm]	$C_{cr,sp}$ [mm]	h_{min} [mm]	h_1 [mm]	h_{nom} [mm]	h_{ef} [mm]	t_{fix} [mm]	$S_{cr,N}$ [mm]	$C_{cr,N}$ [mm]	$S_{cr,sp}$ [mm]	$C_{cr,sp}$ [mm]
TFE	TFE05040	Ø5 x 40(A)	✓*	5	8	SW 8	5	35	35	--	--	--	--	--	--	--	--	--	80	45	35	26,5	5	80	40	80	40
	TFE05050	Ø5 x 50(A)	✓*			SW 8				5	15	105	53	105	53	15											
	TFE05060	Ø5 x 60(B)	✓*			SW 8				35	35	80	55	45	35,0	35											
	TFE05080	Ø5 x 80(D)	✓*			SW 8				55	55	55	55	55	55	55											
	TFE05100	Ø5 x 100(E)	✓*			SW 8				65	65	65	65	65	65	65											
	TFE06040	Ø6 x 40	✓	6	9	SW 10	10	35	35	--	--	--	--	--	--	--	--	--	100	45	35	26,0	5	78	39	90	45
	TFE06050	Ø6 x 50	✓			SW 10				15	15	129	65	170	85	15											
	TFE06060	Ø6 x 60	✓			SW 10				25	25	129	65	170	85	25											
	TFE06070	Ø6 x 70	✓			SW 10				35	35	100	65	55	43,0	35											
	TFE06080	Ø6 x 80	✓			SW 10				45	45	100	65	55	43,0	45											
	TFE06100	Ø6 x 100	✓	SW 10	65	65	100	65	55	43,0	65																
	TFE06120	Ø6 x 120	✓	SW 10	85	85	100	65	55	43,0	85																
	TFE08055	Ø8 x 55	✓	8	12	SW 13	20	35	35	--	--	--	--	--	--	--	--	--	100	60	50	37,5	5	113	57	130	65
	TFE08060	Ø8 x 60	✓			SW 13				10	10	152	76	200	100	10											
	TFE08070	Ø8 x 70	✓			SW 13				20	20	152	76	200	100	20											
	TFE08080	Ø8 x 80	✓			SW 13				30	30	152	76	200	100	30											
	TFE08090	Ø8 x 90	✓			SW 13				40	40	152	76	200	100	40											
	TFE08100	Ø8 x 100	✓			SW 13				50	50	152	76	200	100	50											
	TFE08110	Ø8 x 110	✓			SW 13				60	60	152	76	200	100	60											
	TFE08120	Ø8 x 120	✓			SW 13				70	70	152	76	200	100	70											
	TFE08140	Ø8 x 140	✓			SW 13				90	90	152	76	200	100	90											
	TFE10060	Ø10 x 60	✓			10				14	SW 15	30	50	40	--	--	--	--					--				
	TFE10070	Ø10 x 70	✓	SW 15	15		15	201	101		210				105	15											
	TFE10080	Ø10 x 80	✓	SW 15	25		25	201	101		210				105	25											
	TFE10090	Ø10 x 90	✓	SW 15	35		35	201	101		210				105	35											
	TFE10100	Ø10 x 100	✓	SW 15	45		45	201	101		210				105	45											
	TFE10120	Ø10 x 120	✓	SW 15	65		65	201	101		210				105	65											
	TFE10140	Ø10 x 140	✓	SW 15	85		85	201	101		210				105	85											

*Ø5 Zulassung nur für Verankerungen in Beton und vorgefertigten Spannbeton-Hohldecken für redundante nichttragende Systeme

Allgemeine Einbaukennwerte										Standard-Einbautiefe ($h_{ef, std}$)								Reduzierte Einbautiefe ($h_{ef, red}$)										
Familie	Artikelnr.	Größe (Buchstabe)	Zulassung	Bohrungsdurchmesser	Bohrlochdurchmesser der zu befestigenden	Einbauschlüssel	Max. Einbaudrehmoment	Minimaler Achsabstand	Minimaler Abstand zum Rand	Minimale Betondicke	Bohrlochtiefe	Einbautiefe	Effektive Tiefe	Zu befestigende Dicke	Kritischer Achsabstand	Kritischer Abstand zum Rand (Ausbruch)	Kritischer Achsabstand (Spalten)	Kritischer Abstand zum Rand (Spalten)	Minimale Betondicke	Bohrlochtiefe	Einbautiefe	Effektive Tiefe	Zu befestigende Dicke	Kritischer Achsabstand	Kritischer Abstand zum Rand (Ausbruch)	Kritischer Achsabstand (Spalten)	Kritischer Abstand zum Rand (Spalten)	
[--]	[--]	[--]	ETA	d_0	d_f	SW/Tx	T_{inst}	S_{min}	C_{min}	h_{min}	h_1	h_{nom}	h_{ef}	t_{fix}	$S_{cr,N}$	$C_{cr,N}$	$S_{cr,sp}$	$C_{cr,sp}$	h_{min}	h_1	h_{nom}	h_{ef}	t_{fix}	$S_{cr,N}$	$C_{cr,N}$	$S_{cr,sp}$	$C_{cr,sp}$	
				[mm]	[mm]	[--]	[Nm]	[mm]	[mm]	[mm]	[mm]	[mm]	[mm]	[mm]	[mm]	[mm]	[mm]	[mm]	[mm]	[mm]	[mm]	[mm]	[mm]	[mm]	[mm]	[mm]	[mm]	[mm]
TFE	TFE12080	Ø12 x 80	✓	12	16	SW 18	50	75	45	--	--	--	--	--	--	--	--	--	120	90	75	58,0	5	174	87	190	95	
	TFE12090	Ø12 x 90	✓			SW 18				15																		
	TFE12110	Ø12 x 110	✓			SW 18				25																		
	TFE12130	Ø12 x 130	✓			SW 18				55																		
	TFE12150	Ø12 x 150	✓	SW 18	75																							
	TFE14080	Ø14 x 80	✓	14	18	SW 21	70	80	50	--	--	--	--	--	--	--	--	--	120	90	75	58,0	5	174	87	190	95	
	TFE14100	Ø14 x 100	✓			SW 21				25																		
	TFE14120	Ø14 x 120	✓			SW 21				45																		
	TFE14130	Ø14 x 130	✓			SW 21				55																		
	TFE14140	Ø14 x 140	✓			SW 21				65																		
	TFE14160	Ø14 x 160	✓			SW 21				85																		
	TFE16100	Ø16 x 100	✓	16	20	SW24	80	80	50	--	--	--	--	--	--	--	--	--	115	100	80	58	20	174	87	180	90	
	TFE16150	Ø16 x 150	✓			SW24				70																		
	TFE18100	Ø18 x 100	✓	18	22	SW 24	90	90	55	--	--	--	--	--	--	--	--	--	140	110	90	69,5	10	209	105	230	115	
TFE18130	Ø18 x 130	✓	SW 24			40																						
TFE18160	Ø18 x 160	✓	SW 24			70																						
TFE18180	Ø18 x 180	✓	SW 24			90																						
TFE18200	Ø18 x 200	✓	SW 24			110																						
TFN	TFN14080	Ø14 x 80	✓	14	18	SW 24	70	80	50	--	--	--	--	--	--	--	--	--	120	90	75	58,0	5	174	87	190	95	

Allgemeine Einbaukennwerte										Standard-Einbautiefe ($h_{ef, std}$)								Reduzierte Einbautiefe ($h_{ef, red}$)										
Familie	Artikelnr.	Größe (Buchstabe)	Zulassung	Bohrungsdurchmesser	Bohrlochdurchmesser der zu befestigenden	Einbauschlüssel	Max. Einbaudrehtorque	Minimaler Achsabstand	Minimaler Abstand zum Rand	Minimale Betondecke	Bohrlochtiefe	Einbautiefe	Effektive Tiefe	Zu befestigende Dicke	Kritischer Achsabstand	Kritischer Abstand zum Rand	Kritischer Achsabstand	Kritischer Abstand zum Rand	Minimale Betondecke	Bohrlochtiefe	Einbautiefe	Effektive Tiefe	Zu befestigende Dicke	Kritischer Achsabstand	Kritischer Abstand zum Rand (Ausbruch)	Kritischer Achsabstand (Spalten)	Kritischer Abstand zum Rand (Spalten)	
																												ETA
THA	THA05040	Ø5 x 40(A)	✓*	5	8	TX25	5	35	35	80	55	45	35,0	15	105	53	105	53	80	45	35	26,5	5	80	40	80	40	
	THA05060	Ø5 x 60(B)	✓*			TX25																						25
	THA05080	Ø5 x 80(D)	✓*			TX25																						45
	THA05100	Ø5 x 100(E)	✓*			TX25																						65
	THA06045	Ø6 x 45	✓	6	9	TX30	10	35	35	100	65	55	43,0	5	129	65	170	85	100	45	35	26,0	10	78	39	90	45	
	THA06050	Ø6 x 50	✓			TX30																						15
	THA06060	Ø6 x 60	✓			TX30																						25
	THA06080	Ø6 x 80	✓			TX30																						45
	THA06100	Ø6 x 100	✓			TX30																						65
	THA06120	Ø6 x 120	✓			TX30																						85
	THA08060	Ø8 x 60	✓	8	12	TX45	20	35	35	100	75	65	50,5	15	152	76	200	100	100	60	50	37,5	10	113	57	130	65	
	THA08080	Ø8 x 80	✓			TX45																						30
	THA08100	Ø8 x 100	✓			TX45																						50
	THA08120	Ø8 x 120	✓			TX45																						70
THA10100	Ø10 x 100	✓	10	14	TX50	30	50	40	135	95	85	67,0	15	201	101	210	105	100	65	55	41,5	45	125	63	140	70		
THA10120	Ø10 x 120	✓			TX50																						65	
THT	THT06040	Ø6 x 40	✓	6	9	TX30	10	35	35	100	65	55	43,0	5	129	65	170	85	100	45	35	26,0	5	78	39	90	45	
	THT06050	Ø6 x 50	✓			TX30																						15
	THT06060	Ø6 x 60	✓			TX30																						25
THP	THP05040	Ø5 x 40(A)	✓*	5	8	TX30	5	35	35	80	55	45	35,0	15	105	53	105	53	80	45	35	26,5	5	80	40	80	40	
	THP05060	Ø5 x 60(B)	✓*			TX30																						25
	THP06040	Ø6 x 40	✓	6	9	TX40	10	35	35	100	65	55	43,0	5	129	65	170	85	100	45	35	26,0	15	78	39	90	45	
	THP06050	Ø6 x 50	✓			TX40																						25
	THP06060	Ø6 x 60	✓			TX40																						45
	THP06080	Ø6 x 80	✓			TX40																						65
	THP06100	Ø6 x 100	✓	TX40	85																							
	THP08060	Ø8 x 60	✓	8	12	TX45	20	35	35	100	75	65	50,5	15	152	76	200	100	100	60	50	37,5	10	113	57	130	65	
THP08080	Ø8 x 80	✓	TX45			30																						

*Ø5 Zulassung nur für Verankerungen in Beton und vorgefertigten Spannbeton-Hohldecken für redundante nichttragende Systeme

Allgemeine Einbaukennwerte										Standard-Einbautiefe ($h_{ef, std}$)								Reduzierte Einbautiefe ($h_{ef, red}$)									
Familie	Artikelnr.	Größe (Buchstabe)	Zulassung	Bohrungsdurchmesser	Bohrlochdurchmesser der zu befestigenden	Einbauschlüssel	Max. Einbaudreihmome	Minimaler Achsabstand	Minimaler Abstand zum Rand	Minimale Betondicke	Bohrlochtiefe	Einbautiefe	Effektive Tiefe	Zu befestigende Dicke	Kritischer Achsabstand	Kritischer Abstand zum Rand	Kritischer Achsabstand	Kritischer Abstand zum Rand	Minimale Betondicke	Bohrlochtiefe	Einbautiefe	Effektive Tiefe	Zu befestigende Dicke	Kritischer Achsabstand	Kritischer Abstand zum Rand (Ausbruch)	Kritischer Achsabstand (Spalten)	Kritischer Abstand zum Rand (Spalten)
				d_o [mm]	d_f [mm]																						
TFF	TFF06035	Ø6 x 35 (M8-M10)	✓	6	--	SW 13	10	35	35	--	--	--	--	--	--	--	--	--	100	45	35	26,0	--	78	39	90	45
	TFF06055	Ø6 x 55 (M8-M10)	✓			SW 13				100	65	55	43,0	--	129	65	170	85	--	--	--	--	--	--	--	--	--
TFM	TFM06035	Ø6 x 35 (M8)	✓	6	--	SW 13	10	35	35	--	--	--	--	--	--	--	--	--	100	65	55	26,0	--	78	39	90	45
	TFM06055	Ø6 x 55 (M10)	✓			SW 13				100	65	55	43,0	--	129	65	170	85	--	--	--	--	--	--	--	--	--
TFS	TFS06100	Ø6 x 100 (M8)	✓	6	9	SW 5	10	35	35	100	65	55	43,0	35	129	65	170	85	100	45	35	26,0	55	78	39	90	45
	TFS06120	Ø6 x 120 (M8)	✓			SW 5								75									75				
	TFS08110	Ø8 x 110 (M10)	✓	8	12	SW 7	20	35	35	100	75	65	50,5	32	152	76	200	100	100	60	50	37,5	47	113	57	130	65
	TFS08130	Ø8 x 130 (M10)	✓			SW 7								52									52				
	TFS10120	Ø10 x 120 (M12)	✓	10	14	SW 8	30	50	40	120	85	75	58,5	27	176	88	190	95	100	65	55	41,5	52	125	63	140	70
	TFS10140	Ø10 x 140 (M12)	✓			SW 8								47									47				

4. EINBAUVERFAHREN

4.1 EINBAU IN BETON

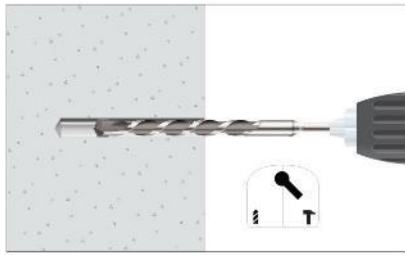

1. BOHRLOCH ERSTELLEN

Sicherstellen, dass der Beton ausreichend verdichtet ist und keine bedeutende Porenbildung aufweist.

Verwendbar mit trockenen, feuchten oder mit Wasser gefüllten Bohrlöchern.

Bohrlocherstellung mittels Schlag- oder Hammerbohren.

Das Bohrloch mit dem spezifizierten Durchmesser und der spezifizierten Tiefe erstellen.



2. AUSBLASEN UND REINIGEN

Das Bohrloch von Staubresten und Bohrungsrückständen reinigen (siehe Grafik).

Hierzu eine Luftpumpe und eine Bürste verwenden.

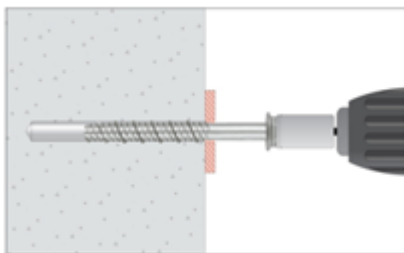

3. EINBAUEN

Einen Schlagschrauber verwenden, der das in den obigen Tabellen angegebene maximale Drehmoment nicht überschreitet.

Für die jeweilige Größe den passenden Innensechskant bzw. das passende Bit verwenden.

Einbau durch das zu befestigende Material.

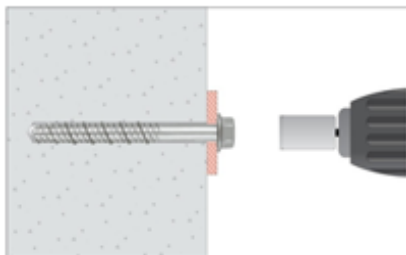

4. FESTZIEHEN

Die Verankerung in das Bohrloch einbringen, bis der Kopf bündig mit der Oberfläche des Baustoffs abschließt.

Der Dübel muss nach der Montage fest sitzen.

5. TRAGFÄHIGKEIT

Die Tragfähigkeitswerte in Beton C20/25 für eine einzelne Verankerung ohne Einwirkung von Rand- oder Achsabstand-Effekten werden in der nachfolgenden Tabelle angegeben:

Unterstrichene und kursiv gedruckte Werte geben das Stahlversagen an; die **fett** gedruckten Werte geben das Versagen durch Betonausbruch und die restlichen das Versagen durch Herausziehen an.

1 KN ≈ 100 kg

5.1 CHARAKTERISTISCHE FESTIGKEIT (TRAGENDE ANWENDUNGEN)[kN]

Allgemeine Parameter				Ungerissener Beton				Gerissener Beton				
Familie	Artikelnr.	Größe	ETA-Zulassung	Zuglast $N_{Rk, ucr}$		Querlast $V_{Rk, ucr}$		Zuglast $N_{Rk, cr}$		Querlast $V_{Rk, cr}$		
				($h_{ef, std}$)	($h_{ef, red}$)	($h_{ef, std}$)	($h_{ef, red}$)	($h_{ef, std}$)	($h_{ef, red}$)	($h_{ef, std}$)	($h_{ef, red}$)	
THE	THE05040	Ø5 x 40	✓*	--	6,71	--	6,71	--	4,70	--	4,70	
	THE05050	Ø5 x 50	✓*									
	THE05060	Ø5 x 60	✓*									
	THE05080	Ø5 x 80	✓*		10,19	6,71	<u>8,19</u>	6,71	7,13	4,70	7,13	4,70
	THE05100	Ø5 x 100	✓*									
	THE06040	Ø6 x 40	✓		--		--		--		--	
	THE06050	Ø6 x 50	✓		--	5,00	--	<u>12,53</u>	--	4,57	--	9,36
	THE06060	Ø6 x 60	✓									
	THE06070	Ø6 x 70	✓									
	THE06080	Ø6 x 80	✓		13,87	5,00	<u>12,53</u>	<u>12,53</u>	9,71	4,57	11,17	9,36
	THE06100	Ø6 x 100	✓									
	THE06120	Ø6 x 120	✓									
	THE08055	Ø8 x 55	✓		--		--		--		--	
	THE08060	Ø8 x 60	✓		--	11,30	--	<u>19,57</u>	--	7,91	--	14,23
	THE08070	Ø8 x 70	✓									
	THE08080	Ø8 x 80	✓									
	THE08090	Ø8 x 90	✓									
	THE08100	Ø8 x 100	✓		17,65	11,30	<u>19,57</u>	<u>19,57</u>	12,36	7,91	15,69	14,23
	THE08110	Ø8 x 110	✓									
	THE08120	Ø8 x 120	✓									
	THE08140	Ø8 x 140	✓									
	THE10060	Ø10 x 60	✓		--		--		--		--	
	THE10070	Ø10 x 70	✓		--	13,15	--	25,65	--	9,21	--	17,95
	THE10080	Ø10 x 80	✓		--		--		--		--	
	THE10090	Ø10 x 90	✓									
	THE10100	Ø10 x 100	✓									
	THE10120	Ø10 x 120	✓		26,98	13,15	<u>27,40</u>	25,65	18,89	9,21	<u>27,40</u>	17,95
	THE10140	Ø10 x 140	✓									
	THE12080	Ø12 x 80	✓		--		--		--		--	
	THE12090	Ø12 x 90	✓		--	21,73	--	<u>37,24</u>	--	15,21	--	35,44
	THE12110	Ø12 x 110	✓									
	THE12130	Ø12 x 130	✓		37,54	21,73	<u>37,24</u>	<u>37,24</u>	26,27	15,21	<u>37,24</u>	35,44
THE12150	Ø12 x 150	✓										
THE14080	Ø14 x 80	✓		--		--		--		--		
THE14100	Ø14 x 100	✓		--	21,73	--	<u>52,72</u>	--	15,21	--	38,79	
THE14120	Ø14 x 120	✓										
THE14130	Ø14 x 130	✓										
THE14140	Ø14 x 140	✓		43,41	21,73	<u>52,72</u>	<u>52,72</u>	30,39	15,21	<u>52,72</u>	38,79	
THE14160	Ø14 x 160	✓										
TFE16100	Ø16 x 100	✓		--	--	--	--	30,39	15,21	<u>52,72</u>	32,55	
TFE16150	Ø16 x 150	✓		43,41	21,73	<u>57,97</u>	46,50	30,39	15,21	<u>52,72</u>	32,55	
THE18100	Ø18 x 100	✓		--		--		--		--		
THE18130	Ø18 x 130	✓		--	28,50	--	75,82	--	19,95	--	53,07	
THE18160	Ø18 x 160	✓										
THE18180	Ø18 x 180	✓										
THE18200	Ø18 x 200	✓		58,31	28,50	<u>80,78</u>	75,82	40,82	19,95	<u>80,78</u>	53,07	

*Ø5 Zulassung nur für Verankerungen in Beton und vorgefertigten Spannbeton-Hohldecken für redundante nichttragende Systeme

Allgemeine Parameter				Ungerissener Beton				Gerissener Beton			
Familie	Artikelnr.	Größe	ETA-Zulassung	Zuglast N _{Rk, ucr}		Querlast V _{Rk, ucr}		Zuglast N _{Rk, cr}		Querlast V _{Rk, cr}	
				(h _{ef, std})	(h _{ef, red})	(h _{ef, std})	(h _{ef, red})	(h _{ef, std})	(h _{ef, red})	(h _{ef, std})	(h _{ef, red})
TFE	TFE05040	Ø5 x 40	✓*	--	6,71	--	6,71	--	4,70	--	4,70
	TFE05050	Ø5 x 50	✓*	10,19	6,71	<u>8,19</u>	6,71	7,13	4,70	7,13	4,70
	TFE05060	Ø5 x 60	✓*								
	TFE05080	Ø5 x 80	✓*								
	TFE05100	Ø5 x 100	✓*								
	TFE06040	Ø6 x 40	✓	--	5,00	--	<u>12,53</u>	--	4,57	--	9,36
	TFE06050	Ø6 x 50	✓	--		--		--		--	
	TFE06060	Ø6 x 60	✓	13,87	5,00	<u>12,53</u>	<u>12,53</u>	9,71	4,57	11,17	9,36
	TFE06070	Ø6 x 70	✓								
	TFE06080	Ø6 x 80	✓								
	TFE06100	Ø6 x 100	✓								
	TFE06120	Ø6 x 120	✓								
	TFE08055	Ø8 x 55	✓	--	11,30	--	<u>19,57</u>	--	7,91	--	14,23
	TFE08060	Ø8 x 60	✓	--		--		--		--	
	TFE08070	Ø8 x 70	✓	17,65	11,30	<u>19,57</u>	<u>19,57</u>	12,36	7,91	15,69	14,23
	TFE08080	Ø8 x 80	✓								
	TFE08090	Ø8 x 90	✓								
	TFE08100	Ø8 x 100	✓								
	TFE08110	Ø8 x 110	✓								
	TFE08120	Ø8 x 120	✓								
	TFE08140	Ø8 x 140	✓	--	13,15	--	25,65	--	9,21	--	17,95
	TFE10060	Ø10 x 60	✓	--		--		--		--	
	TFE10070	Ø10 x 70	✓	--	13,15	--	25,65	--	9,21	--	17,95
	TFE10080	Ø10 x 80	✓	--		--		--		--	
	TFE10090	Ø10 x 90	✓	26,98	13,15	<u>27,40</u>	25,65	18,89	9,21	<u>27,40</u>	17,95
	TFE10100	Ø10 x 100	✓								
	TFE10120	Ø10 x 120	✓								
	TFE10140	Ø10 x 140	✓								
	TFE12080	Ø12 x 80	✓	--	21,73	--	<u>37,24</u>	--	15,21	--	35,44
	TFE12090	Ø12 x 90	✓	--		--		--		--	
	TFE12110	Ø12 x 110	✓	37,54	21,73	<u>37,24</u>	<u>37,24</u>	26,27	15,21	<u>37,24</u>	35,44
	TFE12130	Ø12 x 130	✓								
	TFE12150	Ø12 x 150	✓								
	TFE14080	Ø14 x 80	✓	--	21,73	--	<u>52,72</u>	--	15,21	--	38,79
TFE14100	Ø14 x 100	✓	--	--		--		--			
TFE14120	Ø14 x 120	✓	43,41	21,73	<u>52,72</u>	<u>52,72</u>	30,39	15,21	<u>52,72</u>	38,79	
TFE14130	Ø14 x 130	✓									
TFE14140	Ø14 x 140	✓									
TFE14160	Ø14 x 160	✓									
TFE16100	Ø16 x 100	✓	--	--	--	--	30,39	15,21	<u>52,72</u>	32,55	
TFE16150	Ø16 x 150	✓	43,41	21,73	<u>57,97</u>	46,50					
TFE18100	Ø18 x 100	✓	--	28,50	--	75,82	--	19,95	--	53,07	
TFE18130	Ø18 x 130	✓	--		--		--		--		
TFE18160	Ø18 x 160	✓	58,31	28,50	<u>80,78</u>	75,82	40,82	19,95	<u>80,78</u>	53,07	
TFE18180	Ø18 x 180	✓									
TFE18200	Ø18 x 200	✓									
THA05040	Ø5 x 40	✓*									--
THA05060	Ø5 x 60	✓*	10,19	6,71	<u>8,19</u>	6,71	7,13	4,70	7,13	4,70	
THA05080	Ø5 x 80	✓*									
THA05100	Ø5 x 100	✓*									
THA06045	Ø6 x 45	✓	--	5,00	--	<u>12,53</u>	--	4,57	--	9,36	
THA06050	Ø6 x 50	✓	--		--		--		--		
THA06060	Ø6 x 60	✓	13,87	5,00	<u>12,53</u>	<u>12,53</u>	9,71	4,57	11,17	9,36	
THA06080	Ø6 x 80	✓									
THA06100	Ø6 x 100	✓									
THA06120	Ø6 x 120	✓									
THA06140	Ø6 x 140	✓	--	11,30	--	<u>19,57</u>	--	7,91	--	14,23	
THA08060	Ø8 x 60	✓	--		--		--		--		
THA08080	Ø8 x 80	✓	17,65	11,30	<u>19,57</u>	<u>19,57</u>	12,36	7,91	15,69	14,23	
THA08100	Ø8 x 100	✓									
THA08120	Ø8 x 120	✓									
THA10100	Ø10 x 100	✓									26,98
THA10120	Ø10 x 120	✓									

*Ø5 Zulassung nur für Verankerungen in Beton und vorgefertigten Spannbeton-Hohldecken für redundante nichttragende Systeme

Allgemeine Parameter				Ungerissener Beton				Gerissener Beton			
Familie	Artikelnr.	Größe	ETA-Zulassung	Zuglast $N_{Rk, ucr}$		Querlast $V_{Rk, ucr}$		Zuglast $N_{Rk, cr}$		Querlast $V_{Rk, cr}$	
				($h_{ef, std}$)	($h_{ef, red}$)	($h_{ef, std}$)	($h_{ef, red}$)	($h_{ef, std}$)	($h_{ef, red}$)	($h_{ef, std}$)	($h_{ef, red}$)
THT	THT06040	Ø6 x 40	✓	--	5,00	--	<u>12,53</u>	--	4,57	--	9,36
	THT06050	Ø6 x 50	✓	--	--	--	--	--	--	--	--
	THT06060	Ø6 x 60	✓	13,87	5,00	<u>12,53</u>	<u>12,53</u>	9,71	4,57	11,17	9,36
THP	THP05040	Ø5 x 40	✓*	--	6,71	--	6,71	--	4,70	--	4,70
	THP05060	Ø5 x 60	✓*	10,19	6,71	<u>8,19</u>	6,71	7,13	4,70	7,13	4,70
	THP06040	Ø6 x 40	✓	--	--	--	--	9,71	--	--	--
	THP06050	Ø6 x 50	✓	--	5,00	--	<u>12,53</u>	--	4,57	--	9,36
	THP06060	Ø6 x 60	✓	--	--	--	--	--	--	--	--
	THP06080	Ø6 x 80	✓	13,87	5,00	<u>12,53</u>	<u>12,53</u>	9,71	4,57	11,17	9,36
	THP06100	Ø6 x 100	✓	--	--	--	--	--	--	--	--
	THP08060	Ø8 x 60	✓	--	11,30	--	<u>19,57</u>	--	7,91	--	14,23
	THP08080	Ø8 x 80	✓	17,65	11,30	<u>19,57</u>	<u>19,57</u>	12,36	7,91	15,69	14,23
TFF	TFF06035	Ø6 x 35 (M8-M10)	✓	--	5,00	--	--	--	4,57	--	--
	TFF06055	Ø6 x 55 (M8-M10)	✓	13,87	--	--	--	9,71	--	--	--
TFN	TFN14080	Ø14 x 80	✓	--	21,73	--	<u>52,72</u>	--	15,21	--	38,79
TFM	TFM06035	Ø6 x 35 (M8)	✓	--	5,00	--	--	--	4,57	--	--
	TFM06055	Ø6 x 55 (M10)	✓	13,87	--	--	--	9,71	--	--	--
TFS	TFS06100	Ø6 x 100 (M8)	✓	13,87	5,00	<u>12,53</u>	<u>12,53</u>	9,71	4,57	11,17	9,36
	TFS06120	Ø6 x 120 (M8)	✓	--	--	--	--	--	--	--	--
	TFS08110	Ø8 x 110 (M10)	✓	17,65	11,30	<u>19,57</u>	<u>19,57</u>	12,36	7,91	15,69	14,23
	TFS08130	Ø8 x 130 (M10)	✓	--	--	--	--	--	--	--	--
	TFS10120	Ø10 x 120 (M12)	✓	22,01	13,15	<u>27,40</u>	25,65	15,41	9,21	20,34	17,95
	TFS10140	Ø10 x 140 (M12)	✓	--	--	--	--	--	--	--	--

*Ø5 Zulassung nur für Verankerungen in Beton und vorgefertigten Spannbeton-Hohldecken für redundante nichttragende Systeme

5.2 BEMESSUNGSWERTE DER FESTIGKEIT (TRAGENDE ANWENDUNGEN)[kN]

Allgemeine Parameter				Ungerissener Beton				Gerissener Beton																												
Familie	Artikelnr.	Größe	ETA-Zulassung	Zuglast $N_{Rd,ucr}$		Querlast $V_{Rd,ucr}$		Zuglast $N_{Rd,cr}$		Querlast $V_{Rd,cr}$																										
				($h_{ef, std}$)	($h_{ef, red}$)	($h_{ef, std}$)	($h_{ef, red}$)	($h_{ef, std}$)	($h_{ef, red}$)	($h_{ef, std}$)	($h_{ef, red}$)																									
THE	THE05040	Ø5 x 40	✓*	--	4,47	--	4,47	--	3,13	--	3,13																									
	THE05050	Ø5 x 50	✓*	6,79	4,47	<u>5,46</u>	4,47	4,75	3,13	4,75	3,13																									
	THE05060	Ø5 x 60	✓*																																	
	THE05080	Ø5 x 80	✓*																																	
	THE05100	Ø5 x 100	✓*																																	
	THE06040	Ø6 x 40	✓									--	2,78	--	<u>8,35</u>	--	2,54	--	6,24																	
	THE06050	Ø6 x 50	✓	--	9,25	2,78	<u>8,35</u>	<u>8,35</u>	6,47	2,54	7,44	6,24																								
	THE06060	Ø6 x 60	✓																																	
	THE06070	Ø6 x 70	✓																																	
	THE06080	Ø6 x 80	✓																																	
	THE06100	Ø6 x 100	✓																																	
	THE06120	Ø6 x 120	✓	11,77	6,28	<u>13,05</u>	<u>13,05</u>	8,24	4,39	10,46	9,49																									
	THE08055	Ø8 x 55	✓									--	6,28	--	<u>13,05</u>	--	4,39	--	9,49																	
	THE08060	Ø8 x 60	✓									--	11,77	6,28	<u>13,05</u>	<u>13,05</u>	8,24	4,39	10,46	9,49																
	THE08070	Ø8 x 70	✓																																	
	THE08080	Ø8 x 80	✓																																	
	THE08090	Ø8 x 90	✓																																	
	THE08100	Ø8 x 100	✓																																	
	THE08110	Ø8 x 110	✓	17,99	8,77	<u>18,27</u>	17,10	12,59	6,14	<u>18,27</u>	11,97																									
	THE08120	Ø8 x 120	✓									--	8,77	--	17,10	--	6,14	--	11,97																	
	THE08140	Ø8 x 140	✓									--	17,99	8,77	<u>18,27</u>	17,10	12,59	6,14	<u>18,27</u>	11,97																
	THE10060	Ø10 x 60	✓									--									17,99	8,77	<u>18,27</u>	17,10	12,59	6,14	<u>18,27</u>	11,97								
	THE10070	Ø10 x 70	✓									--																	17,99	8,77	<u>18,27</u>	17,10	12,59	6,14	<u>18,27</u>	11,97
	THE10080	Ø10 x 80	✓	--	17,99	8,77	<u>18,27</u>	17,10	12,59	6,14	<u>18,27</u>	11,97																								
	THE10090	Ø10 x 90	✓	--																																
	THE10100	Ø10 x 100	✓	--									17,99	8,77	<u>18,27</u>	17,10	12,59	6,14	<u>18,27</u>	11,97																
	THE10120	Ø10 x 120	✓	--																	17,99	8,77	<u>18,27</u>	17,10	12,59	6,14	<u>18,27</u>	11,97								
	THE10140	Ø10 x 140	✓	--																									17,99	8,77	<u>18,27</u>	17,10	12,59	6,14	<u>18,27</u>	11,97
	THE12080	Ø12 x 80	✓	--	25,02	14,49	<u>24,83</u>	<u>24,83</u>	17,52	10,14	<u>24,83</u>	23,63																								
	THE12090	Ø12 x 90	✓	--																																
	THE12110	Ø12 x 110	✓	--									25,02	14,49	<u>24,83</u>	<u>24,83</u>	17,52	10,14	<u>24,83</u>	23,63																
	THE12130	Ø12 x 130	✓	--																	25,02	14,49	<u>24,83</u>	<u>24,83</u>	17,52	10,14	<u>24,83</u>	23,63								
THE12150	Ø12 x 150	✓	--	25,02																									14,49	<u>24,83</u>	<u>24,83</u>	17,52	10,14	<u>24,83</u>	23,63	
THE14080	Ø14 x 80	✓	--		28,94	14,49	<u>35,15</u>	<u>35,15</u>	20,26	10,14	<u>35,15</u>	25,86																								
THE14100	Ø14 x 100	✓	--																																	28,94
THE14120	Ø14 x 120	✓	--										28,94	14,49	<u>35,15</u>	<u>35,15</u>	20,26	10,14	<u>35,15</u>	25,86																
THE14130	Ø14 x 130	✓	--																		28,94	14,49	<u>35,15</u>	<u>35,15</u>	20,26	10,14	<u>35,15</u>	25,86								
THE14140	Ø14 x 140	✓	--	28,94																									14,49	<u>35,15</u>	<u>35,15</u>	20,26	10,14	<u>35,15</u>	25,86	
THE14160	Ø14 x 160	✓	--		28,94	14,49	<u>35,15</u>	<u>35,15</u>	20,26	10,14	<u>35,15</u>	25,86																								
THE16100	Ø16 x 100	✓	--																																	28,94
THE16150	Ø16 x 150	✓	--										28,94	14,49	<u>38,65</u>	31,00	20,26	10,14	<u>38,65</u>	21,70																
THE18100	Ø18 x 100	✓	--																		38,87	19,00	<u>53,85</u>	50,54	27,21	13,30	<u>53,85</u>	35,38								
THE18130	Ø18 x 130	✓	--	38,87																									19,00	<u>53,85</u>	50,54	27,21	13,30	<u>53,85</u>	35,38	
THE18160	Ø18 x 160	✓	--		38,87	19,00	<u>53,85</u>	50,54	27,21	13,30	<u>53,85</u>	35,38																								
THE18180	Ø18 x 180	✓	--																																	38,87
THE18200	Ø18 x 200	✓	--										38,87	19,00	<u>53,85</u>	50,54	27,21	13,30	<u>53,85</u>	35,38																

*Ø5 Zulassung nur für Verankerungen in Beton und vorgefertigten Spannbeton-Hohldecken für redundante nichttragende Systeme

Allgemeine Parameter				Ungerissener Beton				Gerissener Beton			
Familie	Artikelnr.	Größe	ETA-Zulassung	Zuglast $N_{Rk, ucr}$		Querlast $V_{Rk, ucr}$		Zuglast $N_{Rk, cr}$		Querlast $V_{Rk, cr}$	
				($h_{ef, std}$)	($h_{ef, red}$)	($h_{ef, std}$)	($h_{ef, red}$)	($h_{ef, std}$)	($h_{ef, red}$)	($h_{ef, std}$)	($h_{ef, red}$)
TFE	TFE05040	Ø5 x 40	✓*	--	4,47	--	4,47	--	3,13	--	3,13
	TFE05050	Ø5 x 50	✓*	6,79	4,47	5,46	4,47	4,75	3,13	4,75	3,13
	TFE05060	Ø5 x 60	✓*								
	TFE05080	Ø5 x 80	✓*								
	TFE05100	Ø5 x 100	✓*								
	TFE06040	Ø6 x 40	✓	--	2,78	--	8,35	--	2,54	--	6,24
	TFE06050	Ø6 x 50	✓								
	TFE06060	Ø6 x 60	✓	9,25	2,78	8,35	8,35	6,47	2,54	7,44	6,24
	TFE06070	Ø6 x 70	✓								
	TFE06080	Ø6 x 80	✓								
	TFE06100	Ø6 x 100	✓								
	TFE06120	Ø6 x 120	✓								
	TFE06140	Ø6 x 140	✓								
	TFE08055	Ø8 x 55	✓	--	6,28	--	13,05	--	4,39	--	9,49
	TFE08060	Ø8 x 60	✓								
	TFE08070	Ø8 x 70	✓	11,77	6,28	13,05	13,05	8,24	4,39	10,46	9,49
	TFE08080	Ø8 x 80	✓								
	TFE08090	Ø8 x 90	✓								
	TFE08100	Ø8 x 100	✓								
	TFE08110	Ø8 x 110	✓								
	TFE08120	Ø8 x 120	✓								
	TFE08140	Ø8 x 140	✓								
	TFE10060	Ø10 x 60	✓	--	8,77	--	17,10	--	6,14	--	11,97
	TFE10070	Ø10 x 70	✓								
	TFE10080	Ø10 x 80	✓								
	TFE10090	Ø10 x 90	✓								
	TFE10100	Ø10 x 100	✓	17,99	8,77	18,27	17,10	12,59	6,14	18,27	11,97
	TFE10120	Ø10 x 120	✓								
	TFE10140	Ø10 x 140	✓								
	TFE12080	Ø12 x 80	✓								
	TFE12090	Ø12 x 90	✓								
	TFE12110	Ø12 x 110	✓	25,02	14,49	24,83	24,83	17,52	10,14	24,83	23,63
TFE12130	Ø12 x 130	✓									
TFE12150	Ø12 x 150	✓									
TFE14080	Ø14 x 80	✓	--								
TFE14100	Ø14 x 100	✓									
TFE14120	Ø14 x 120	✓	28,94	14,49	35,15	35,15	20,26	10,14	35,15	25,86	
TFE14130	Ø14 x 130	✓									
TFE14140	Ø14 x 140	✓									
TFE14160	Ø14 x 160	✓									
TFE16100	Ø16 x 100	✓	--	--	--	--	20,26	10,14	38,65	21,70	
TFE16150	Ø16 x 150	✓									
TFE18100	Ø18 x 100	✓	--	19,00	--	50,54	--	13,30	--	35,38	
TFE18130	Ø18 x 130	✓									
TFE18160	Ø18 x 160	✓	38,87	19,00	53,85	50,54	27,21	13,30	53,85	35,38	
TFE18180	Ø18 x 180	✓									
TFE18200	Ø18 x 200	✓									
THA05040	Ø5 x 40	✓*									--
THA05060	Ø5 x 60	✓*	6,79	4,47	5,46	4,47	4,75	3,13	4,75	3,13	
THA05080	Ø5 x 80	✓*									
THA05100	Ø5 x 100	✓*									
THA06045	Ø6 x 45	✓									--
THA06050	Ø6 x 50	✓									
THA06060	Ø6 x 60	✓	9,25	2,78	8,35	8,35	6,47	2,54	7,44	6,24	
THA06080	Ø6 x 80	✓									
THA06100	Ø6 x 100	✓									
THA06120	Ø6 x 120	✓									
THA06140	Ø6 x 140	✓									
THA08060	Ø8 x 60	✓									--
THA08080	Ø8 x 80	✓									
THA08100	Ø8 x 100	✓	11,77	6,28	13,05	13,05	8,24	4,39	10,46	9,49	
THA08120	Ø8 x 120	✓									
THA10100	Ø10 x 100	✓									
THA10120	Ø10 x 120	✓									

*Ø5 Zulassung nur für Verankerungen in Beton und vorgefertigten Spannbeton-Hohldecken für redundante nichttragende Systeme

Allgemeine Parameter				Ungerissener Beton				Gerissener Beton			
Familie	Artikelnr.	Größe	ETA-Zulassung	Zuglast $N_{Rk, ucr}$		Querlast $V_{Rk, ucr}$		Zuglast $N_{Rk, cr}$		Querlast $V_{Rk, cr}$	
				($h_{ef, std}$)	($h_{ef, red}$)	($h_{ef, std}$)	($h_{ef, red}$)	($h_{ef, std}$)	($h_{ef, red}$)	($h_{ef, std}$)	($h_{ef, red}$)
THT	THT06040	Ø6 x 40	✓	--	2,78	--	<u>8,35</u>	--	2,54	--	6,24
	THT06050	Ø6 x 50	✓	--	--	--	--	--	--	--	--
	THT06060	Ø6 x 60	✓	9,25	2,78	<u>8,35</u>	<u>8,35</u>	6,47	2,54	7,44	6,24
THP	THP05040	Ø5 x 40	✓*	--	4,47	--	4,47	--	3,13	--	3,13
	THP05060	Ø5 x 60	✓*	6,79	4,47	<u>5,46</u>	4,47	4,75	3,13	4,75	3,13
	THP06040	Ø6 x 40	✓	--	2,78	--	<u>8,35</u>	--	2,54	--	6,24
	THP06050	Ø6 x 50	✓	--	--	--	--	--	--	--	--
	THP06060	Ø6 x 60	✓	--	--	--	--	--	--	--	--
	THP06080	Ø6 x 80	✓	9,25	2,78	<u>8,35</u>	<u>8,35</u>	6,47	2,54	7,44	6,24
	THP06100	Ø6 x 100	✓	--	--	--	--	--	--	--	--
	THP08060	Ø8 x 60	✓	--	6,28	--	<u>13,05</u>	--	4,39	--	9,49
	THP08080	Ø8 x 80	✓	11,77	6,28	<u>13,05</u>	<u>13,05</u>	8,24	4,39	10,46	9,49
TFN	TFN14080	Ø14 x 80	✓	--	14,49	--	35,15	--	10,14	--	25,86
TFF	TFF06035	Ø6 x 35 (M8-M10)	✓	--	2,78	--	--	--	2,54	--	--
	TFF06055	Ø6 x 55 (M8-M10)	✓	9,25	--	--	--	6,47	--	--	--
TFM	TFM06035	Ø6 x 35 (M8)	✓	--	2,78	--	--	--	2,54	--	--
	TFM06055	Ø6 x 55 (M10)	✓	9,25	--	--	--	6,47	--	--	--
TFS	TFS06100	Ø6 x 100 (M8)	✓	9,25	2,78	<u>8,35</u>	<u>8,35</u>	6,47	2,54	7,44	6,24
	TFS06120	Ø6 x 120 (M8)	✓								
	TFS08110	Ø8 x 110 (M10)	✓	11,77	6,28	<u>13,05</u>	<u>13,05</u>	8,24	4,39	10,46	9,49
	TFS08130	Ø8 x 130 (M10)	✓								
	TFS10120	Ø10 x 120 (M12)	✓	14,67	8,77	<u>18,27</u>	17,10	10,27	6,14	13,56	11,97
	TFS10140	Ø10 x 140 (M12)	✓								

*Ø5 Zulassung nur für Verankerungen in Beton und vorgefertigten Spannbeton-Hohldecken für redundante nichttragende Systeme

5.3 MAX. EMPFOHLENE ZUGFESTIGKEIT (TRAGENDE ANWENDUNGEN) [kN] (wenn $\gamma_F=1,4$) [kN]

Allgemeine Parameter				Ungerissener Beton				Gerissener Beton			
Familie	Artikelnr.	Größe	ETA-Zulassung	Zuglast $N_{rec,ucr}$		Querlast $V_{rec,ucr}$		Zuglast $N_{rec,cr}$		Querlast $V_{rec,cr}$	
				($h_{ef,sta}$)	($h_{ef,red}$)	($h_{ef,sta}$)	($h_{ef,red}$)	($h_{ef,sta}$)	($h_{ef,red}$)	($h_{ef,sta}$)	($h_{ef,red}$)
THE	THE05040	Ø5 x 40	✓*	--	3,20	--	3,20	--	2,24	--	2,24
	THE05050	Ø5 x 50	✓*	4,85	3,20	<u>3,90</u>	3,20	3,40	2,24	3,40	2,24
	THE05060	Ø5 x 60	✓*								
	THE05080	Ø5 x 80	✓*								
	THE05100	Ø5 x 100	✓*								
	THE06040	Ø6 x 40	✓	--	1,98	--	<u>5,97</u>	--	1,81	--	4,46
	THE06050	Ø6 x 50	✓	6,61	1,98	<u>5,97</u>	<u>5,97</u>	4,62	1,81	5,32	4,46
	THE06060	Ø6 x 60	✓								
	THE06070	Ø6 x 70	✓								
	THE06080	Ø6 x 80	✓								
	THE06100	Ø6 x 100	✓								
	THE06120	Ø6 x 120	✓								
	THE08055	Ø8 x 55	✓	--	4,48	--	<u>9,32</u>	--	3,14	--	6,78
	THE08060	Ø8 x 60	✓	8,41	4,48	<u>9,32</u>	<u>9,32</u>	5,88	3,14	7,47	6,78
	THE08070	Ø8 x 70	✓								
	THE08080	Ø8 x 80	✓								
	THE08090	Ø8 x 90	✓								
	THE08100	Ø8 x 100	✓								
	THE08110	Ø8 x 110	✓								
	THE08120	Ø8 x 120	✓								
	THE08140	Ø8 x 140	✓								
	THE10060	Ø10 x 60	✓	--	6,26	--	12,21	--	4,38	--	8,55
	THE10070	Ø10 x 70	✓	12,85	6,26	<u>13,05</u>	12,21	8,99	4,38	<u>13,05</u>	8,55
	THE10080	Ø10 x 80	✓								
	THE10090	Ø10 x 90	✓								
	THE10100	Ø10 x 100	✓								
	THE10120	Ø10 x 120	✓								
	THE10140	Ø10 x 140	✓								
	THE12080	Ø12 x 80	✓	--	10,35	--	<u>17,73</u>	--	7,24	--	16,88
	THE12090	Ø12 x 90	✓	17,87	10,35	<u>17,73</u>	<u>17,73</u>	12,51	7,24	<u>17,73</u>	16,88
	THE12110	Ø12 x 110	✓								
	THE12130	Ø12 x 130	✓								
THE12150	Ø12 x 150	✓									
THE14080	Ø14 x 80	✓	--	10,35	--	<u>25,10</u>	--	7,24	--	18,47	
THE14100	Ø14 x 100	✓	20,67	10,35	<u>25,10</u>	<u>25,10</u>	14,47	7,24	<u>25,10</u>	18,47	
THE14120	Ø14 x 120	✓									
THE14130	Ø14 x 130	✓									
THE14140	Ø14 x 140	✓									
THE14160	Ø14 x 160	✓									
THE16100	Ø16 x 100	✓	--	--	--	--	14,47	7,24	<u>27,60</u>	15,50	
THE16150	Ø16 x 150	✓	20,67	10,35	<u>27,60</u>	22,14	14,47	7,24	<u>27,60</u>	15,50	
THE18100	Ø18 x 100	✓	--	13,57	--	36,10	--	9,50	--	25,27	
THE18130	Ø18 x 130	✓	27,77	13,57	<u>38,47</u>	36,10	19,44	9,50	<u>38,47</u>	25,27	
THE18160	Ø18 x 160	✓									
THE18180	Ø18 x 180	✓									
THE18200	Ø18 x 200	✓									

*Ø5 Zulassung nur für Verankerungen in Beton und vorgefertigten Spannbeton-Hohldecken für redundante nichttragende Systeme

Allgemeine Parameter				Ungerissener Beton				Gerissener Beton			
Familie	Artikelnr.	Größe	ETA-Zulassung	Zuglast $N_{Rk, ucr}$		Querlast $V_{Rk, ucr}$		Zuglast $N_{Rk, cr}$		Querlast $V_{Rk, cr}$	
				($h_{ef, std}$)	($h_{ef, red}$)	($h_{ef, std}$)	($h_{ef, red}$)	($h_{ef, std}$)	($h_{ef, red}$)	($h_{ef, std}$)	($h_{ef, red}$)
TFE	TFE05040	Ø5 x 40	✓*	--	3,20	--	3,20	--	2,24	--	2,24
	TFE05050	Ø5 x 50	✓*	4,85	3,20	<u>3,90</u>	3,20	3,40	2,24	3,40	2,24
	TFE05060	Ø5 x 60	✓*								
	TFE05080	Ø5 x 80	✓*								
	TFE05100	Ø5 x 100	✓*								
	TFE06040	Ø6 x 40	✓	--	1,98	--	<u>5,97</u>	--	1,81	--	4,46
	TFE06050	Ø6 x 50	✓								
	TFE06060	Ø6 x 60	✓	6,61	1,98	<u>5,97</u>	<u>5,97</u>	4,62	1,81	5,32	4,46
	TFE06070	Ø6 x 70	✓								
	TFE06080	Ø6 x 80	✓								
	TFE06100	Ø6 x 100	✓								
	TFE06120	Ø6 x 120	✓								
	TFE08055	Ø8 x 55	✓								
	TFE08060	Ø8 x 60	✓								
	TFE08070	Ø8 x 70	✓	8,41	4,48	<u>9,32</u>	<u>9,32</u>	5,88	3,14	7,47	6,78
	TFE08080	Ø8 x 80	✓								
	TFE08090	Ø8 x 90	✓								
	TFE08100	Ø8 x 100	✓								
	TFE08110	Ø8 x 110	✓								
	TFE08120	Ø8 x 120	✓								
	TFE08140	Ø8 x 140	✓	--	6,26	--	12,21	--	4,38	--	8,55
	TFE10060	Ø10 x 60	✓								
	TFE10070	Ø10 x 70	✓	--	6,26	--	12,21	--	4,38	--	8,55
	TFE10080	Ø10 x 80	✓								
	TFE10090	Ø10 x 90	✓	12,85	6,26	<u>13,05</u>	12,21	8,99	4,38	<u>13,05</u>	8,55
	TFE10100	Ø10 x 100	✓								
	TFE10120	Ø10 x 120	✓								
	TFE10140	Ø10 x 140	✓								
	TFE12080	Ø12 x 80	✓	--	10,35	--	<u>17,73</u>	--	7,24	--	16,88
	TFE12090	Ø12 x 90	✓								
	TFE12110	Ø12 x 110	✓	17,87	10,35	<u>17,73</u>	<u>17,73</u>	12,51	7,24	<u>17,73</u>	16,88
	TFE12130	Ø12 x 130	✓								
	TFE12150	Ø12 x 150	✓								
	TFE14080	Ø14 x 80	✓	--	10,35	--	<u>25,10</u>	--	7,24	--	18,47
TFE14100	Ø14 x 100	✓									
TFE14120	Ø14 x 120	✓	20,67	10,35	<u>25,10</u>	<u>25,10</u>	14,47	7,24	<u>25,10</u>	18,47	
TFE14130	Ø14 x 130	✓									
TFE14140	Ø14 x 140	✓									
TFE14160	Ø14 x 160	✓									
TFE16100	Ø16 x 100	✓	--	--	--	--	14,47	7,24	<u>27,60</u>	15,50	
TFE16150	Ø16 x 150	✓	20,67	10,35	<u>27,60</u>	22,14	14,47	7,24	<u>27,60</u>	15,50	
TFE18100	Ø18 x 100	✓	--	13,57	--	36,10	--	9,50	--	25,27	
TFE18130	Ø18 x 130	✓									
TFE18160	Ø18 x 160	✓	27,77	13,57	<u>38,47</u>	36,10	20,26	9,50	<u>38,47</u>	25,27	
TFE18180	Ø18 x 180	✓									
TFE18200	Ø18 x 200	✓									
THA05040	Ø5 x 40	✓*									--
THA05060	Ø5 x 60	✓*	4,85	3,20	<u>3,90</u>	3,20	3,40	2,24	3,40	2,24	
THA05080	Ø5 x 80	✓*									
THA05100	Ø5 x 100	✓*									
THA06045	Ø6 x 45	✓	--	1,98	--	<u>5,97</u>	--	1,81	--	4,46	
THA06050	Ø6 x 50	✓									
THA06060	Ø6 x 60	✓	6,61	1,98	<u>5,97</u>	<u>5,97</u>	4,62	1,81	5,32	4,46	
THA06080	Ø6 x 80	✓									
THA06100	Ø6 x 100	✓									
THA06120	Ø6 x 120	✓									
THA06140	Ø6 x 140	✓	--	4,48	--	<u>9,32</u>	--	3,14	--	6,78	
THA08060	Ø8 x 60	✓									
THA08080	Ø8 x 80	✓	8,41	4,48	<u>9,32</u>	<u>9,32</u>	5,88	3,14	7,47	6,78	
THA08100	Ø8 x 100	✓									
THA08120	Ø8 x 120	✓									
THA10100	Ø10 x 100	✓									
THA10120	Ø10 x 120	✓	12,85	6,26	<u>13,05</u>	12,21	8,99	4,38	<u>13,05</u>	8,55	

*Ø5 Zulassung nur für Verankerungen in Beton und vorgefertigten Spannbeton-Hohldecken für redundante nichttragende Systeme

Allgemeine Parameter				Ungerissener Beton				Gerissener Beton			
Familie	Artikelnr.	Größe	ETA-Zulassung	Zuglast $N_{Rk, ucr}$		Querlast $V_{Rk, ucr}$		Zuglast $N_{Rk, cr}$		Querlast $V_{Rk, cr}$	
				($h_{ef, std}$)	($h_{ef, red}$)	($h_{ef, std}$)	($h_{ef, red}$)	($h_{ef, std}$)	($h_{ef, red}$)	($h_{ef, std}$)	($h_{ef, red}$)
THT	THT06040	Ø6 x 40	✓	--	1,98	--	<u>5,97</u>	--	1,81	--	4,46
	THT06050	Ø6 x 50	✓	--	--	--	--	--	--	--	--
	THT06060	Ø6 x 60	✓	6,61	1,98	<u>5,97</u>	<u>5,97</u>	4,62	1,81	5,32	4,46
THP	THP05040	Ø5 x 40	✓*	--	3,20	--	3,20	--	2,24	--	2,24
	THP05060	Ø5 x 60	✓*	4,85	3,20	<u>3,90</u>	3,20	3,40	2,24	3,40	2,24
	THP06040	Ø6 x 40	✓	--	1,98	--	<u>5,97</u>	--	1,81	--	4,46
	THP06050	Ø6 x 50	✓	--	--	--	--	--	--	--	--
	THP06060	Ø6 x 60	✓	6,61	1,98	<u>5,97</u>	<u>5,97</u>	4,62	1,81	5,32	4,46
	THP06080	Ø6 x 80	✓	--	4,48	--	<u>9,32</u>	--	3,14	--	6,78
	THP06100	Ø6 x 100	✓	8,41	4,48	<u>9,32</u>	<u>9,32</u>	5,88	3,14	7,47	6,78
	THP08060	Ø8 x 60	✓	--	4,48	--	<u>9,32</u>	--	3,14	--	6,78
	THP08080	Ø8 x 80	✓	8,41	4,48	<u>9,32</u>	<u>9,32</u>	5,88	3,14	7,47	6,78
TFN	TFN14080	Ø14 x 80	✓	--	10,35	--	25,10	--	7,24	--	18,47
TFF	TFF06035	Ø6 x 35 (M8-M10)	✓	--	1,98	--	--	--	1,81	--	--
	TFF06055	Ø6 x 55 (M8-M10)	✓	6,61	--	--	--	4,62	--	--	--
TFM	TFM06035	Ø6 x 35 (M8)	✓	--	1,98	--	--	--	1,81	--	--
	TFM06055	Ø6 x 55 (M10)	✓	6,61	--	--	--	4,62	--	--	--
TFS	TFS06100	Ø6 x 100 (M8)	✓	6,61	1,98	<u>5,97</u>	<u>5,97</u>	4,62	1,81	5,32	4,46
	TFS06120	Ø6 x 120 (M8)	✓	--	--	--	--	--	--	--	--
	TFS08110	Ø8 x 110 (M10)	✓	8,41	4,48	<u>9,32</u>	<u>9,32</u>	5,88	3,14	7,47	6,78
	TFS08130	Ø8 x 130 (M10)	✓	--	--	--	--	--	--	--	--
	TFS10120	Ø10 x 120 (M12)	✓	10,48	6,26	<u>13,05</u>	12,21	7,34	4,38	9,68	8,55
	TFS10140	Ø10 x 140 (M12)	✓	--	--	--	--	--	--	--	--

*Ø5 Zulassung nur für Verankerungen in Beton und vorgefertigten Spannbeton-Hohldecken für redundante nichttragende Systeme

**VERGRÖßERUNGSFAKTOREN FÜR HERAUSZIEHEN
UNTER ZUGBEANSPRUCHUNG FÜR HOCHFESTEN BETON ψ_c**

Durchmesser	Ø5		Ø6		Ø8		Ø10			Ø12		Ø14		Ø18	
Einbautiefe	($h_{ef, red}$)	($h_{ef, std}$)	($h_{ef, red}$)	($h_{ef, std}$)	($h_{ef, red}$)	($h_{ef, std}$)	($h_{ef, 1}$)	($h_{ef, 2}$)	($h_{ef, 3}$)	($h_{ef, red}$)	($h_{ef, std}$)	($h_{ef, red}$)	($h_{ef, std}$)	($h_{ef, red}$)	($h_{ef, std}$)
C30/37	1,00	1,00	1,16	1,22	1,21	1,22	1,22	1,17	1,22	1,16	1,22	1,21	1,20	1,22	1,17
C40/50	1,00	1,00	1,28	1,41	1,39	1,41	1,41	1,30	1,41	1,29	1,41	1,39	1,37	1,40	1,32
C50/60	1,00	1,00	1,39	1,58	1,54	1,58	1,58	1,42	1,58	1,40	1,58	1,55	1,51	1,57	1,42

6. OFFIZIELLE DOKUMENTE

Bei unserer Vertriebsabteilung oder über unsere Website www.indexfix.com können Sie folgende Dokument erhalten:

- EU-Zulassung ETA 20/0046 für den Einbau in gerissenem und ungerissenem Beton gemäß EAD 330232-00-0601, Option 1, von Ø6 bis Ø18.
- Europäische Zulassung ETA 20/0494 für die Verwendung in Beton- und Fertigteil-Hohlkörperplatten für redundante nichttragende Systeme gemäß EAD-Richtlinie 330747-00-0601 von Ø5 bis Ø6.
- Leistungserklärung DoP THE.
- Erfüllt die Richtlinie VdS CEA 4001:2021-01(07) „Richtlinien für Sprinkleranlagen. Planung und Einbau für Anwendungen von Wasserlöschanlagen auf Betonelementen“ von Ø6 bis Ø18.
- Erhältlich für das Berechnungsprogramm für Verankerungen INDEXcal.